

Carlo

Design:

TONO & RENATO JAIME MORGANTI



+ info: <https://www.depadova.com/materials.pdf>

De Padova srl - info@depadova.it

TABLE

Materials

Base

veneered plywood ash panel (class E1, CARB P2 / TSCA Title VI certified), charcoal-stained, finished with transparent water-based or solvent-based coating. Or MDF (class E1, CARB P2 / TSCA Title VI certified) direct high-gloss lacquered (polyester colour range). Thermoplastic adjustable feet.

Top

veneered plywood ash panel (class E1, CARB P2 / TSCA Title VI certified), charcoal-stained, with edge in aniline-dyed solid charcoal-stained ash, finished with transparent water-based or solvent-based coating. Or MDF (class E1, CARB P2 / TSCA Title VI certified) direct high-gloss lacquered (polyester colour range).

Marble top

Calacatta Oro marble, Valentine Grey, Grey Stone, Emperador Dark, grey Carnico marble, treated with water repellent products or finished with matt polyester. Table top with matt black lacquered MDF support.

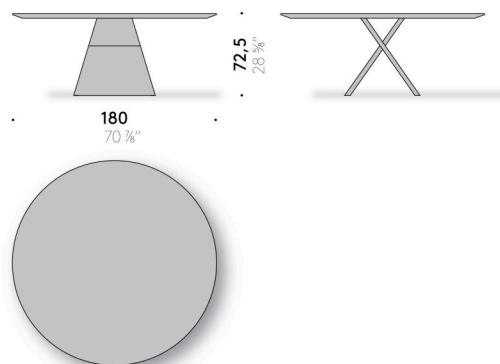
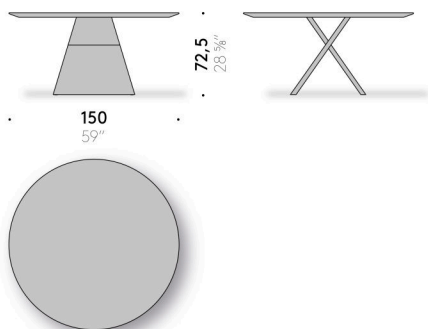

Carlo

Design:

TONO & RENATO JAIME MORGANTI



+ info: <https://www.depadova.com/materials.pdf>

De Padova srl - info@depadova.it

TAVOLO

Materiali

Base

pannello in multistrato (certificato classe E1, CARB P2 / TSCA Title VI) impiallacciato in frassino tinto color carbone finito con vernice trasparente a base acqua o a base solvente. Oppure MDF (certificato classe E1, CARB P2 / TSCA Title VI) laccato lucido diretto (gamma colori poliestere). Piedini regolabili in materiale termoplastico.

Piano

pannello in multistrato (certificato classe E1, CARB P2 / TSCA Title VI) impiallacciato in frassino tinto color carbone, con bordo in massello di frassino tinto all'anilina color carbone, finito con vernice trasparente a base acqua o a base solvente. Oppure MDF (certificato classe E1, CARB P2 / TSCA Title VI) laccato lucido diretto (gamma colori poliestere).

Piano in marmo

marmo Calacatta Oro, Valentine Grey, Grey Stone, Emperador Dark, Grigio Carnico, trattato con prodotti idrorepellenti oppure finito con poliestere opaco. Piano dotato di supporto in MDF laccato nero opaco.

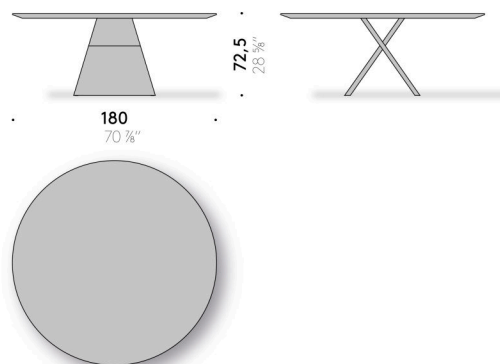
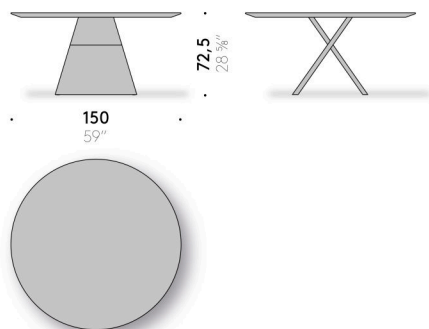

Carlo

Design:

TONO & RENATO JAIME MORGANTI



+ info: <https://www.depadova.com/materials.pdf>

De Padova srl - info@depadova.it

TABLE

Matériaux

Base

panneau de multiplis (certifiée classe E1, CARB P2 / TSCA Title VI), plaqué frêne teinté couleur charbon fini avec peinture transparente à l'eau ou à base de solvant. Ou MDF (certifié classe E1, CARB P2 / TSCA Title VI) laqué brillant direct (gamme couleurs polyester). Pieds réglables en thermoplastique.

Dessus

panneau de multiplis (certifiée classe E1, CARB P2 / TSCA Title VI), plaqué frêne, teinté couleur charbon, avec bord en massif de frêne teinté à l'aniline couleur charbon, fini avec peinture transparente à l'eau ou à base de solvant. Ou MDF (certifié classe E1, CARB P2 / TSCA Title VI) laqué brillant direct (gamme couleurs polyester).

Dessus en marbre

marbre Calacatta Oro, Valentine Grey, Grey Stone, Emperador Dark, Gris Carnique, traité avec des produits hydrofuges ou fini avec du polyester mat. Dessus doté de support en MDF laqué noir mat.

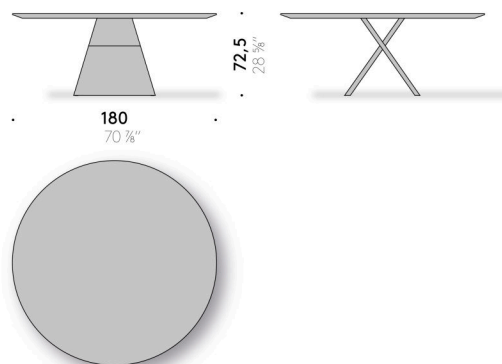
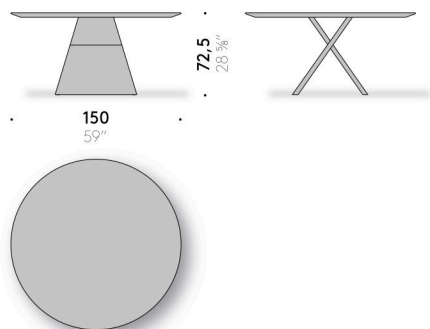

Carlo

Design:

TONO & RENATO JAIME MORGANTI



+ info: <https://www.depadova.com/materials.pdf>

De Padova srl - info@depadova.it

TISCH

Materialien

Gestell

Paneel in Schichtholz (zertifiziert Klasse E1, CARB P2 / TSCA Title VI), furniert in Esche kohlschwarz gebeizt, endbehandelt mit transparentem Lack auf Wasser- oder Lösemittelbasis. Oder in MDF (zertifiziert Klasse E1, CARB P2 / TSCA Title VI), hochglänzend lackiert (Polyester-Farbbereich). Verstellbare Thermoplast-FüÙe.

Tischplatte

Paneel in Schichtholz (zertifiziert Klasse E1, CARB P2 / TSCA Title VI), furniert in Esche kohlschwarz gebeizt, mit Tischkante aus massiver Esche, anilingefärbt kohlschwarz gebeizt, endbehandelt mit transparentem Lack auf Wasser- oder Lösemittelbasis. Oder in MDF (zertifiziert Klasse E1, CARB P2 / TSCA Title VI), hochglänzend lackiert (Polyester-Farbbereich).

Tischplatte aus Marmor

Marmor Calacatta Oro, Valentine Grey, Grey Stone, Emperador Dark, Grau Carnico, mit wasserabweisenden Produkten behandelt oder mit mattem Polyester beschichtet. Tischplatte mit Untergestell aus mattschwarz lackiertem MDF.

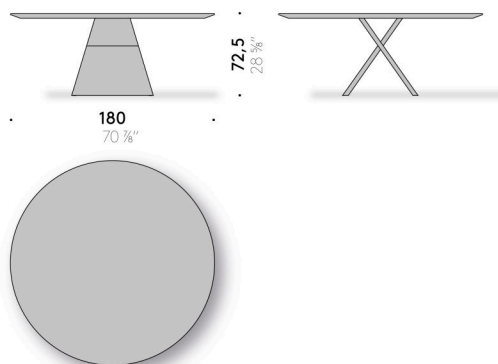
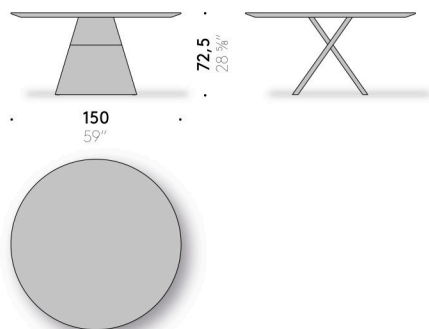

Carlo

Design:

TONO & RENATO JAIME MORGANTI



+ info: <https://www.depadova.com/materials.pdf>

De Padova srl - info@depadova.it

MESA

Materiales

Base

panel de multicapa (certificado clase E1, CARB P2 / TSCA Title VI) chapado con fresno teñido color carbón acabado con barniz transparente al agua o al disolvente. O MDF (certificado clase E1, CARB P2 / TSCA Title VI) lacado brillante directo (gama de colores poliéster). Pies ajustables de material termoplástico.

Tablero

panel de multicapa (certificado clase E1, CARB P2 / TSCA Title VI) chapado con fresno teñido color carbón, con borde de madera maciza de fresno teñido a la anilina color carbón, acabado con barniz transparente al agua o al disolvente. O MDF (certificado clase E1, CARB P2 / TSCA Title VI) lacado brillante directo (gama de colores poliéster).

Tablero de mármol

mármol Calacatta Oro, Valentine Grey, Grey Stone, Emperador Dark, Gris de Carnia tratado con productos repelentes al agua o acabado con poliéster mate. Tablero equipado con soporte de MDF lacado negro mate.

